

# Evariste III: A new multi-FPGA system for fair benchmarking of hardware dependent cryptographic primitives

Nathalie Bochard, Cédric Marchand, Oto Petura, Lilian Bossuet, Viktor Fischer  
 Laboratoire Hubert Curien, UMR 5516 CNRS - Université Jean Monnet, Saint-Etienne, France

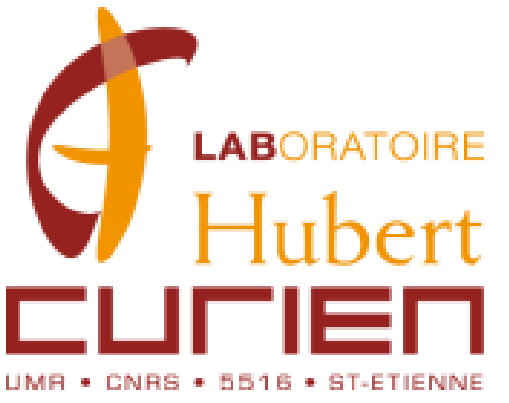

## What's new?

- 3 new FPGA modules, one with an embedded ARM processor
- Motherboard with ZIF (zero insertion force) connectors
- Serial connection of up to 6 modules via JTAG
- Box with 6 motherboards interconnected and chained
- 30 modules of each new FPGA family for PUF evaluation available
- SMA connectors in all modules for side channel analysis added

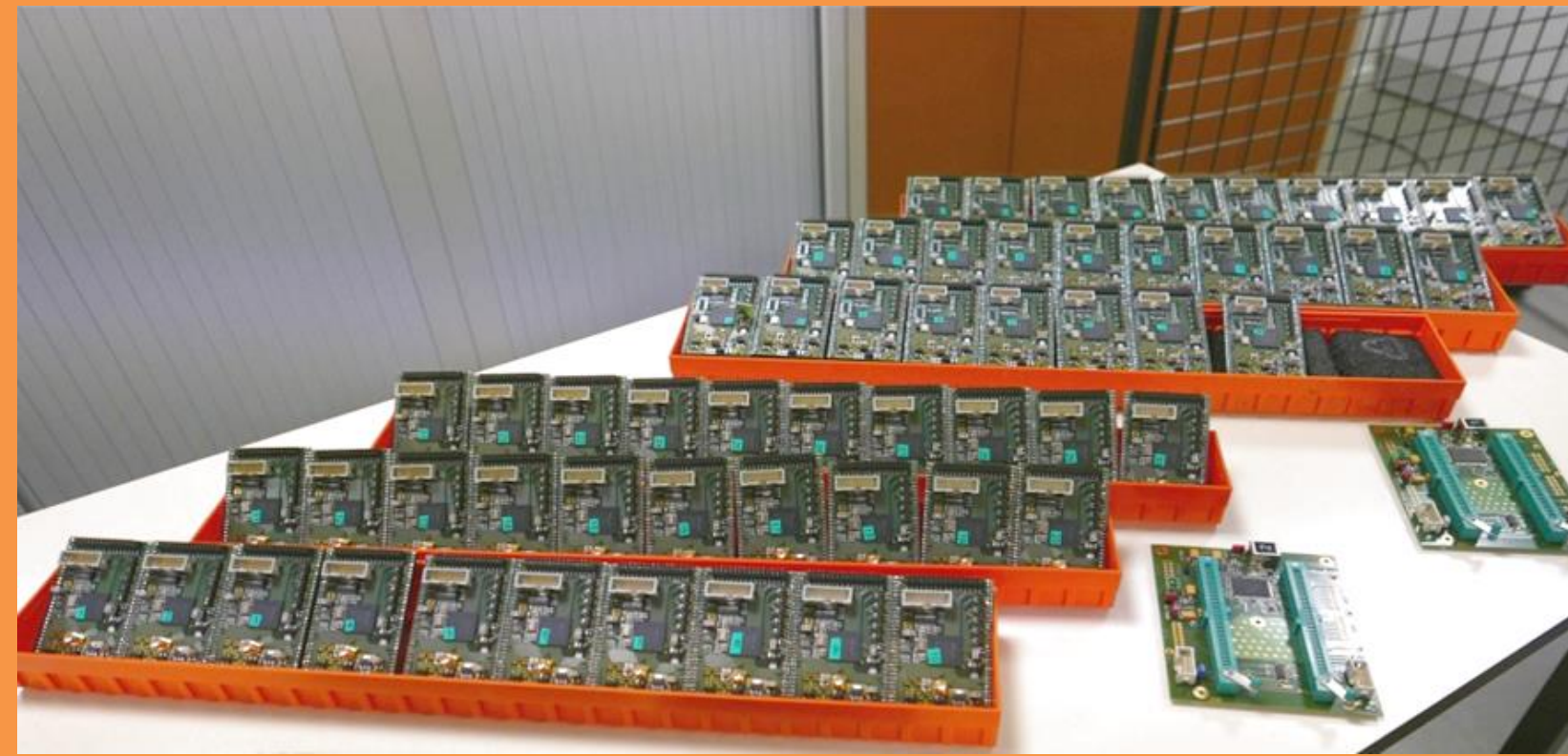

## 3 new modules:

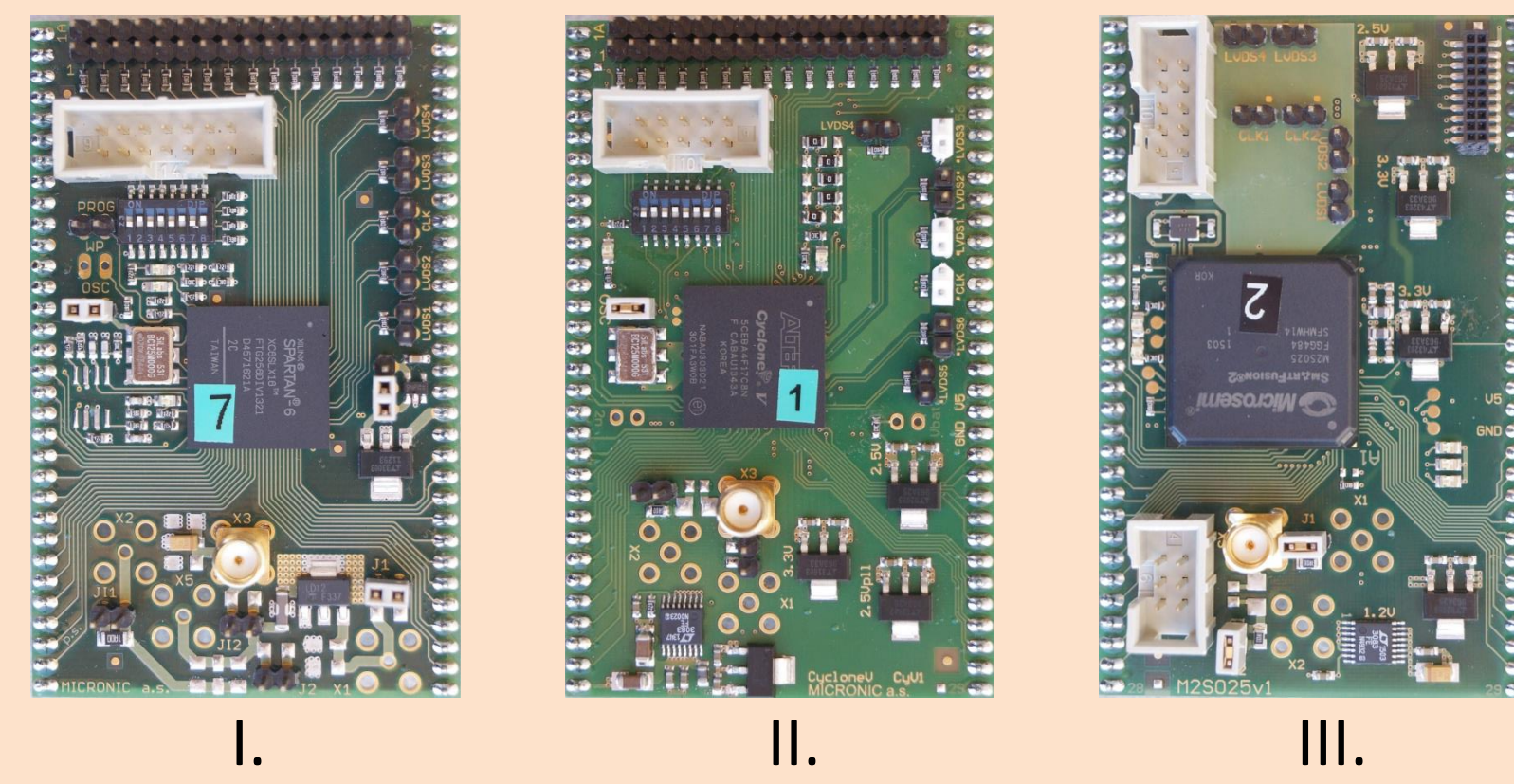

- I. Xilinx Spartan 6
- II. Altera Cyclone V
- III. Microsemi SmartFusion2 with ARM Cortex-M3

- New motherboard
  - ZIF connectors
  - JTAG chain I/O

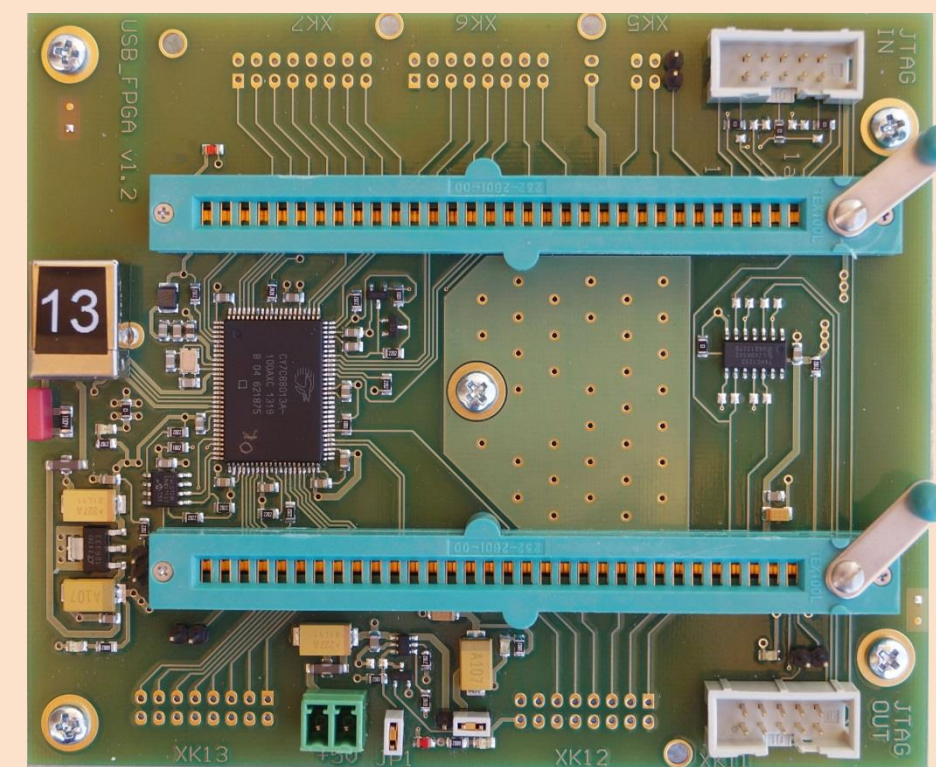

## Compatible with old modules:

1. Xilinx Spartan 3
2. Xilinx Virtex V
3. Altera Cyclone III (3 versions)
4. Altera Aria II
5. Microsemi Fusion (2 versions)
6. ASIC controlled with Fusion FPGA

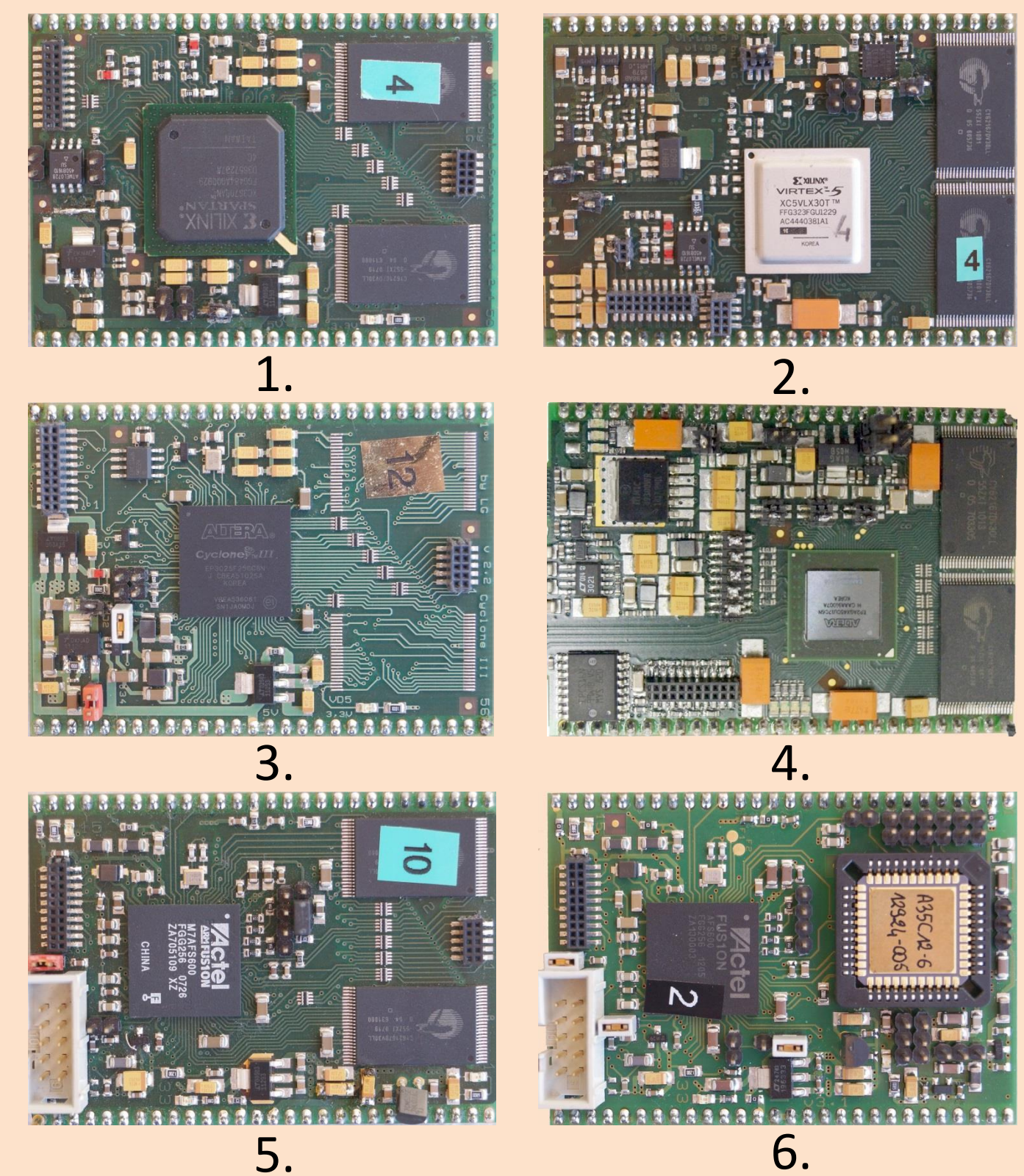

## Inherited from Evariste II<sup>1</sup>

- Both scripting and fast acquisition data programs
- Open source system
- Remotely available via Internet
- Fast USB interface

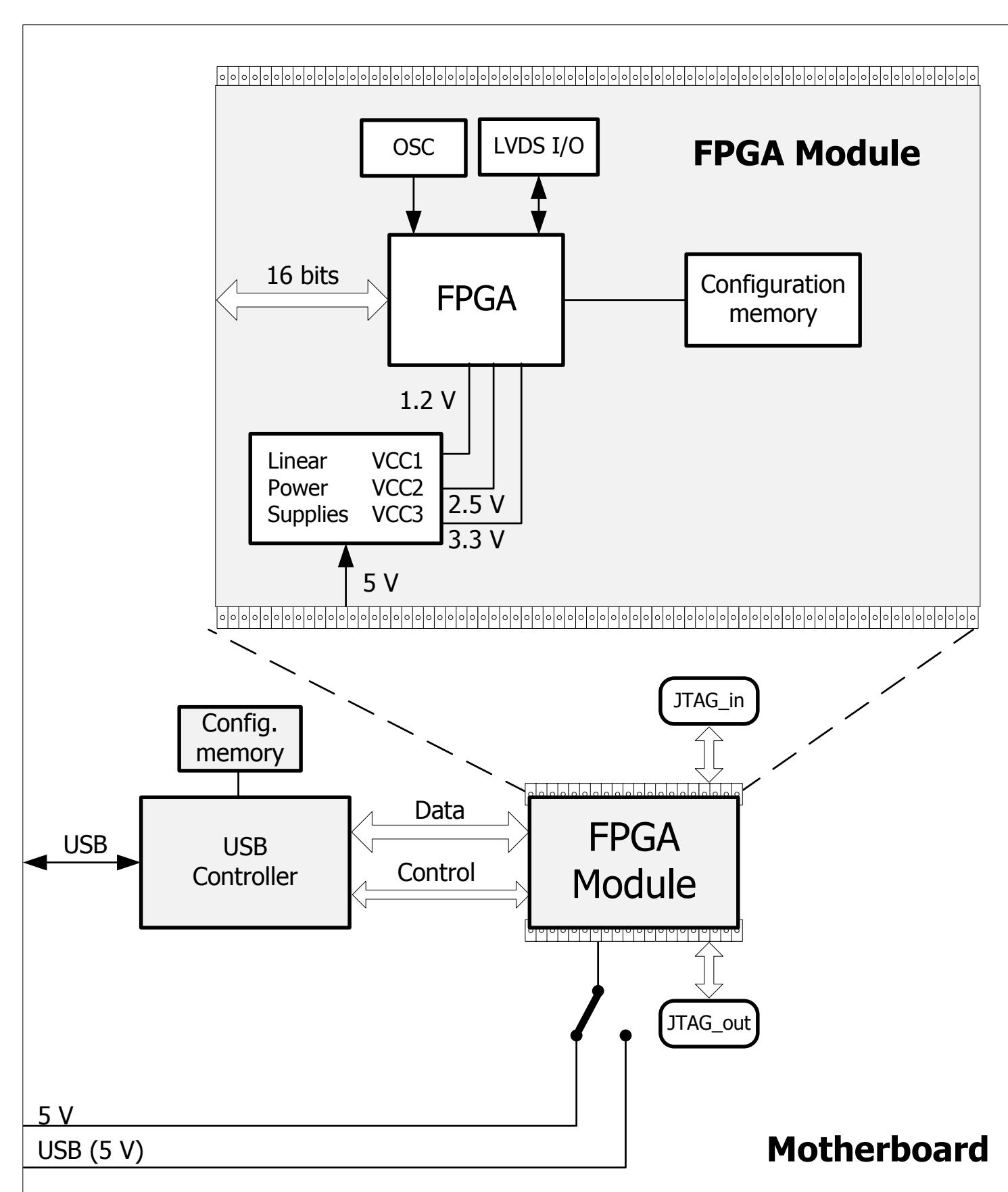

## TRNGs

System dedicated to True Random Number Generators

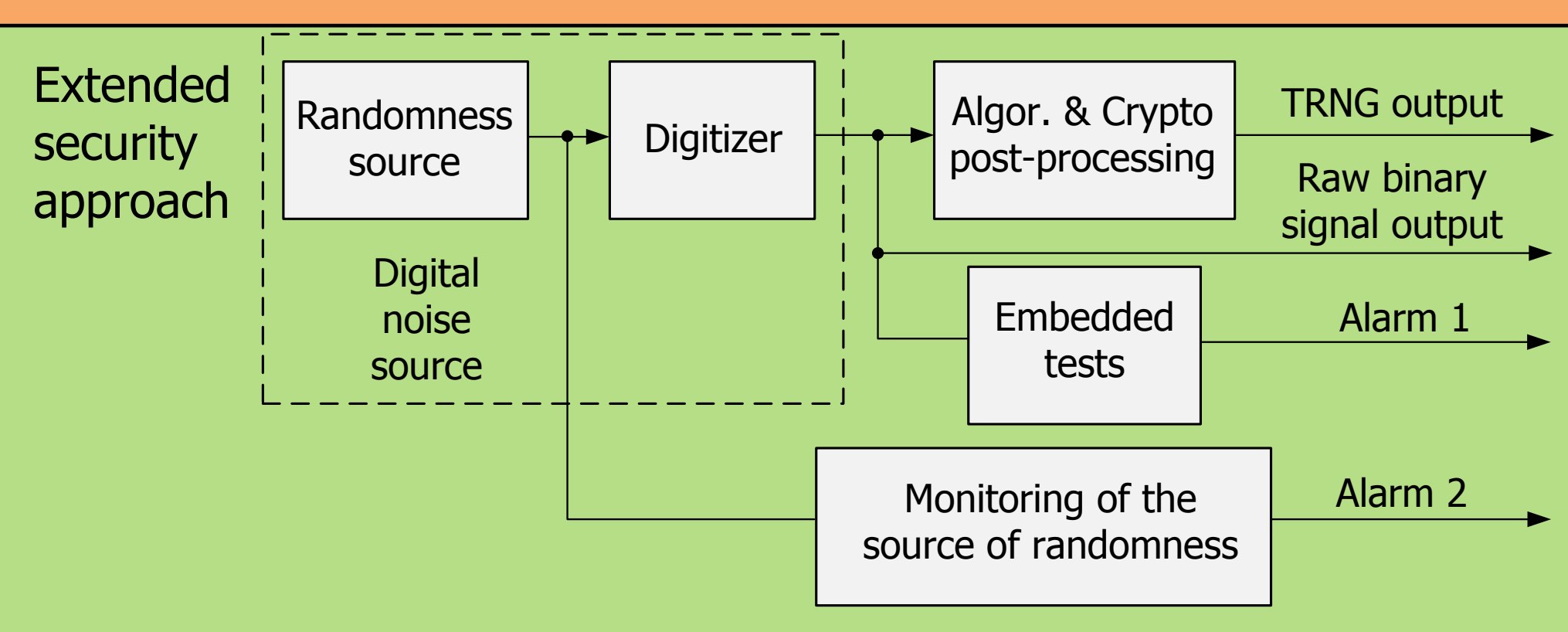

First historical application, fair TRNG comparison thanks to:

- Unified hardware platform for different FPGA and ASIC technologies
- Linear power supply
- High quality low pass filters

## SCAs

System dedicated to Side Channel Analyses

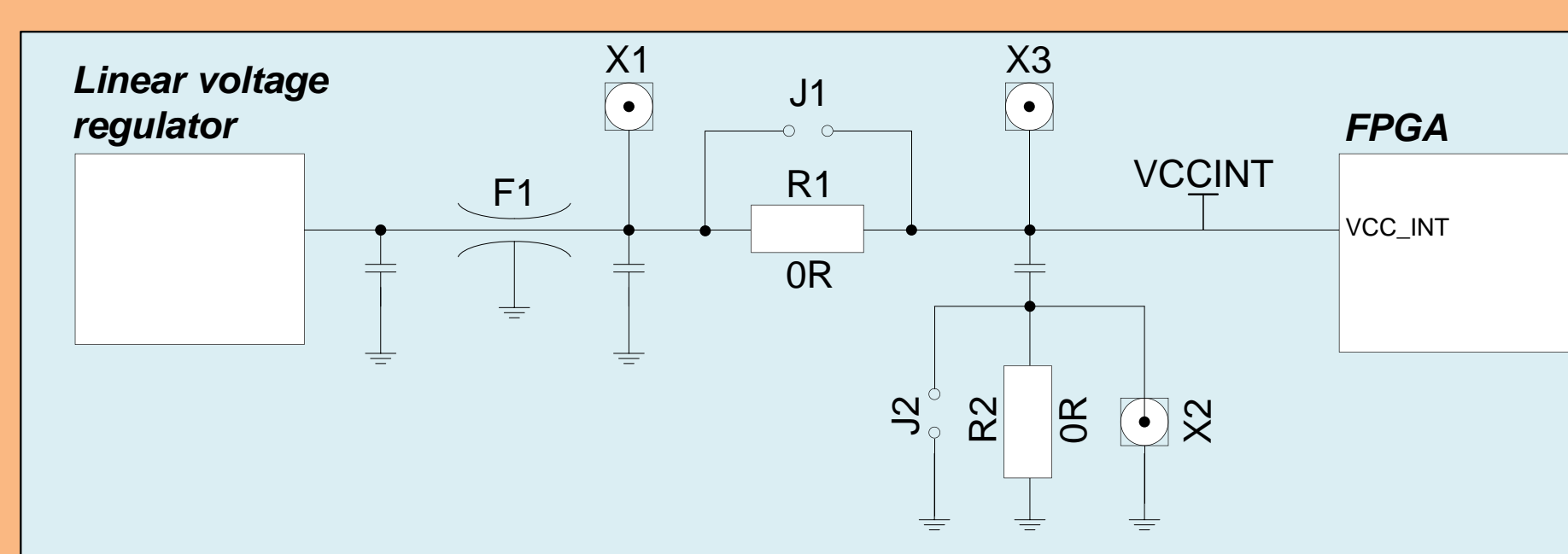

- Access to power supply lines in different places of the design
- SMA connectors for easier access and performance
- Embedded ARM processor in new modules to study software primitives

## PUFs

System dedicated to Physical Unclonable Functions

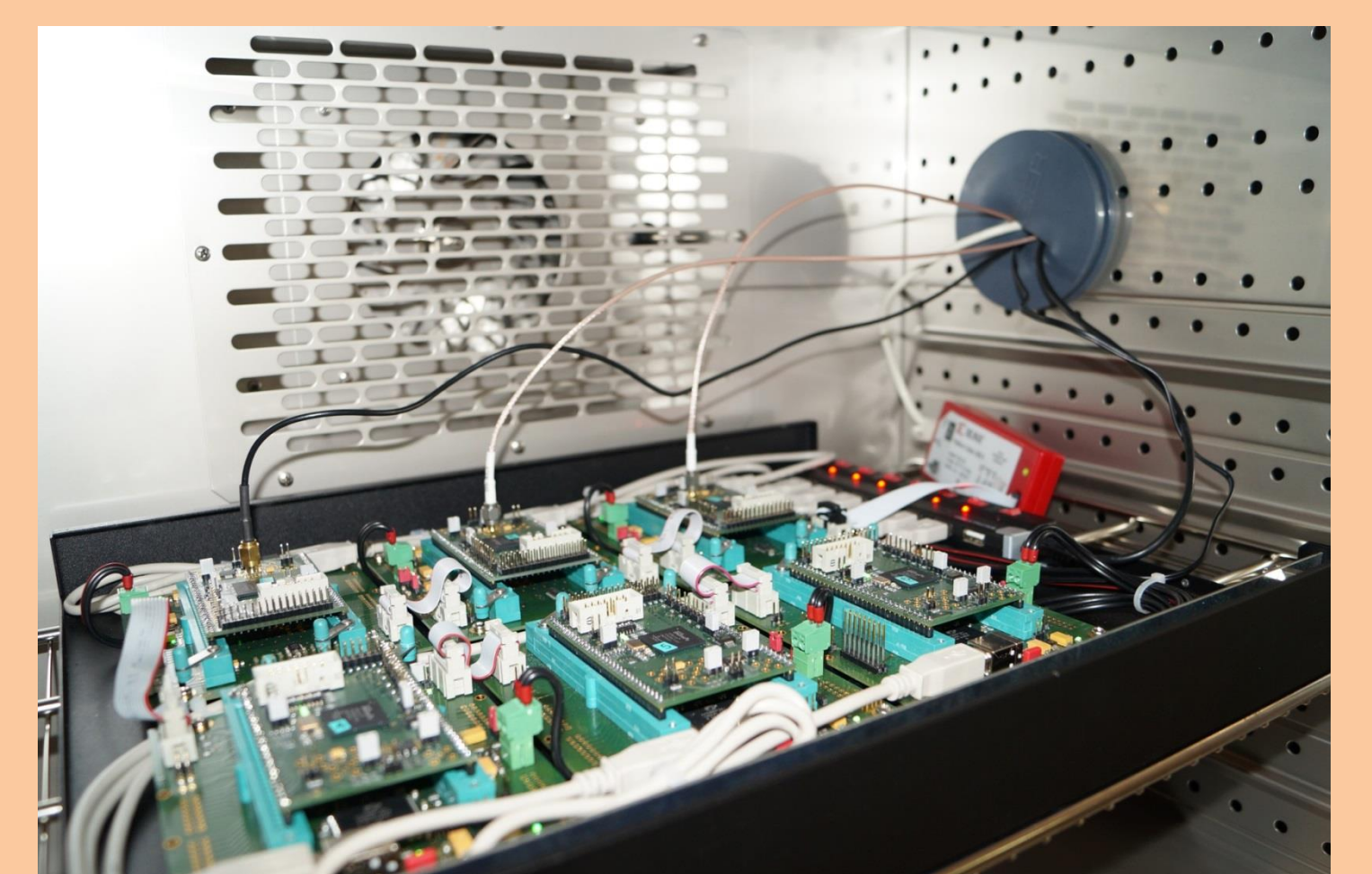

- Evaluation of up to 6 modules in parallel with 6 motherboards placed in a box
- JTAG chain for reconfiguration in situ
- Zero insertion force connectors to facilitate exchange of modules

1. FISCHER V., HADDAD P., BERNARD F., (2013) : « An open-source multi-FPGA modular system for fair benchmarking of true random number generators », 23rd international conference on field programmable logic and applications (FPL2013), pp. PS3\_8, Porto, Portugal

<http://labh-curien.univ-st-etienne.fr/wiki-evariste/>



Sources of funding:

European Union's Horizon 2020 research and innovation program: HECTOR - Hardware Enabled Crypto and Randomness - grant agreement No 644052.  
 ANR 2013 call: SALWARE - Salutory hardware design to fight against integrated circuit counterfeiting and theft - ANR-13-JS03-0003.  
 NATO SFP (Science for Peace) 2013: SFPP 984520 "Secure implementation of post-quantum cryptography".

