



**HAL**  
open science

# **Evariste III: A new multi-FPGA system for fair benchmarking of hardware dependent cryptographic primitives**

Nathalie Bochard, Cédric Marchand, Oto Petura, Lilian Bossuet, Viktor Fischer

► **To cite this version:**

Nathalie Bochard, Cédric Marchand, Oto Petura, Lilian Bossuet, Viktor Fischer. Evariste III: A new multi-FPGA system for fair benchmarking of hardware dependent cryptographic primitives. Workshop on Cryptographic Hardware and Embedded Systems, CHES 2015, Sep 2015, st-malo, France. 2015. ujm-01219840

**HAL Id: ujm-01219840**

**<https://ujm.hal.science/ujm-01219840>**

Submitted on 26 Oct 2015

**HAL** is a multi-disciplinary open access archive for the deposit and dissemination of scientific research documents, whether they are published or not. The documents may come from teaching and research institutions in France or abroad, or from public or private research centers.

L'archive ouverte pluridisciplinaire **HAL**, est destinée au dépôt et à la diffusion de documents scientifiques de niveau recherche, publiés ou non, émanant des établissements d'enseignement et de recherche français ou étrangers, des laboratoires publics ou privés.



# Evariste III: A new multi-FPGA system for fair benchmarking of hardware dependent cryptographic primitives

Nathalie Bochard, Cédric Marchand, Oto Petura, Lilian Bossuet, Viktor Fischer  
 Laboratoire Hubert Curien, UMR 5516 CNRS - Université Jean Monnet, Saint-Etienne, France



## What's new?

- 3 new FPGA modules, one with an embedded ARM processor
- Motherboard with ZIF (zero insertion force) connectors
- Serial connection of up to 6 modules via JTAG
- Box with 6 motherboards interconnected and chained
- 30 modules of each new FPGA family for PUF evaluation available
- SMA connectors in all modules for side channel analysis added



## 3 new modules:

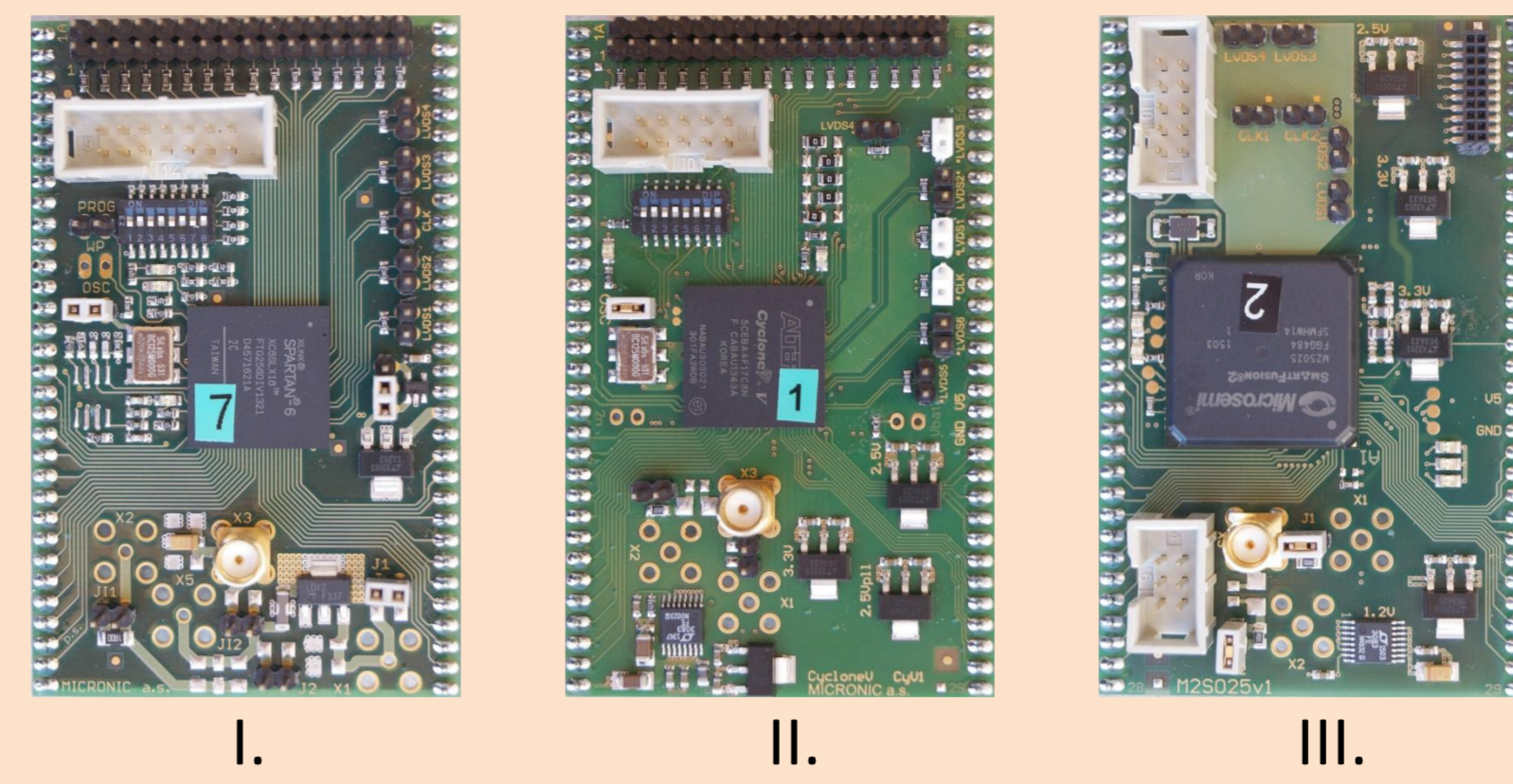

- I. Xilinx Spartan 6
- II. Altera Cyclone V
- III. Microsemi SmartFusion2 with ARM Cortex-M3

- New motherboard
  - ZIF connectors
  - JTAG chain I/O

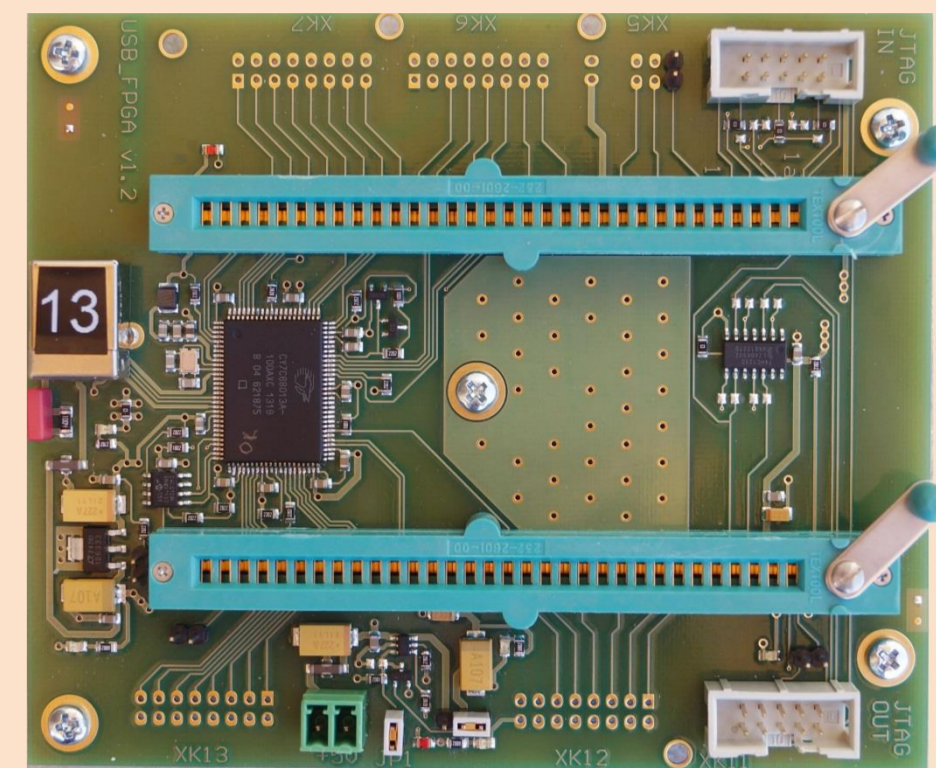

## Compatible with old modules:

1. Xilinx Spartan 3
2. Xilinx Virtex V
3. Altera Cyclone III (3 versions)
4. Altera Aria II
5. Microsemi Fusion (2 versions)
6. ASIC controlled with Fusion FPGA

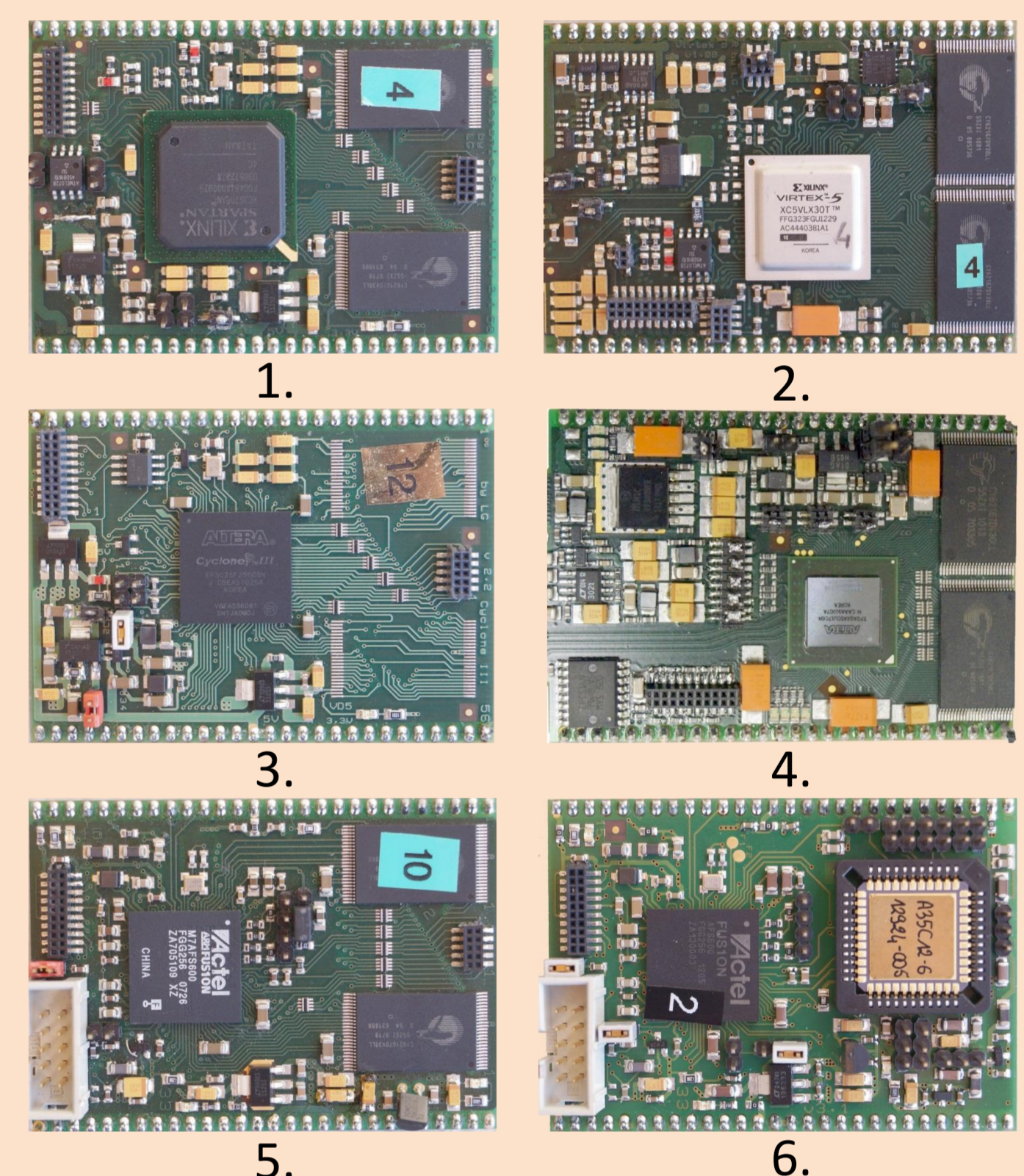

## Inherited from Evariste II<sup>1</sup>

- Both scripting and fast acquisition data programs
- Open source system
- Remotely available via Internet
- Fast USB interface

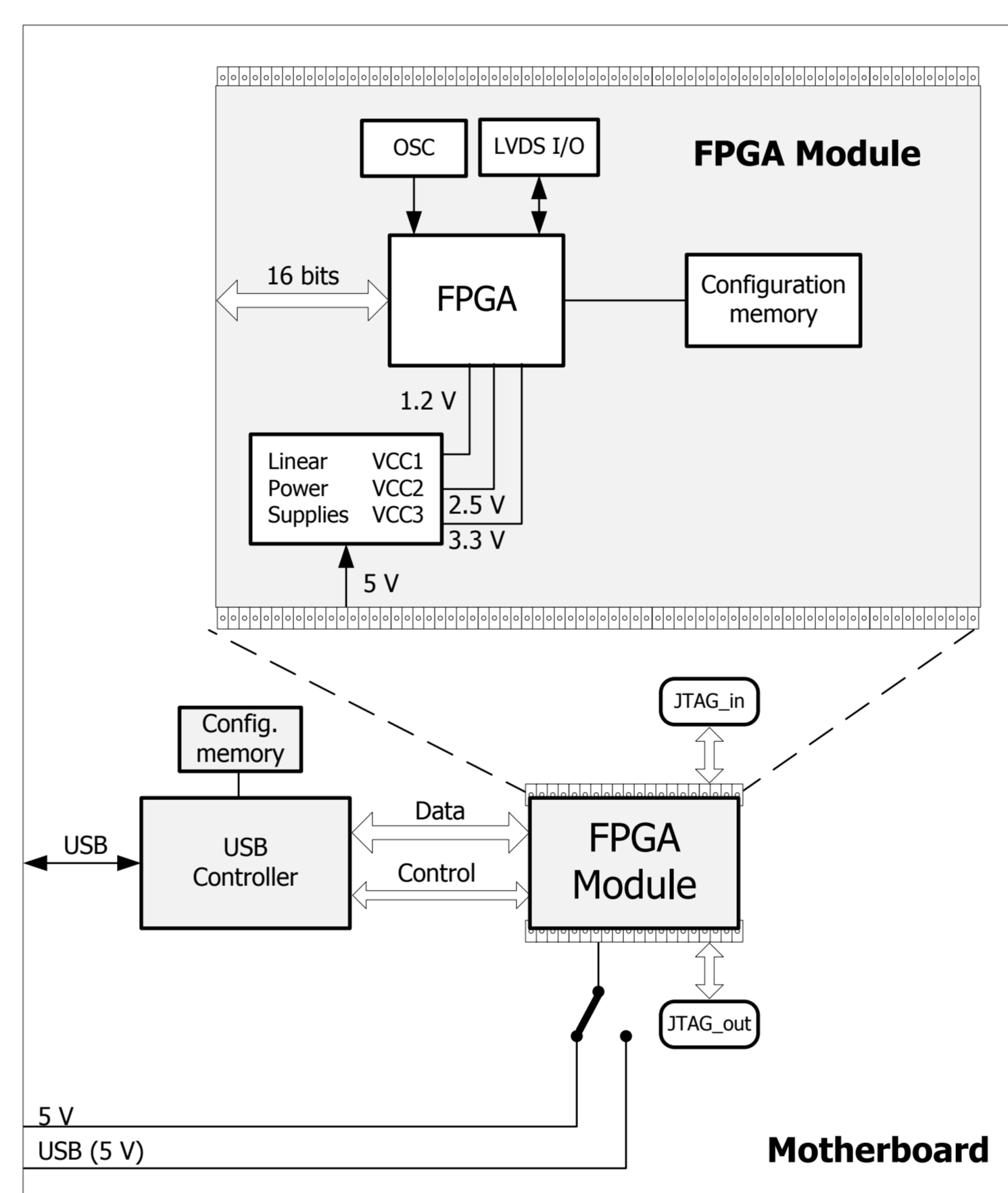

## TRNGs

System dedicated to True Random Number Generators

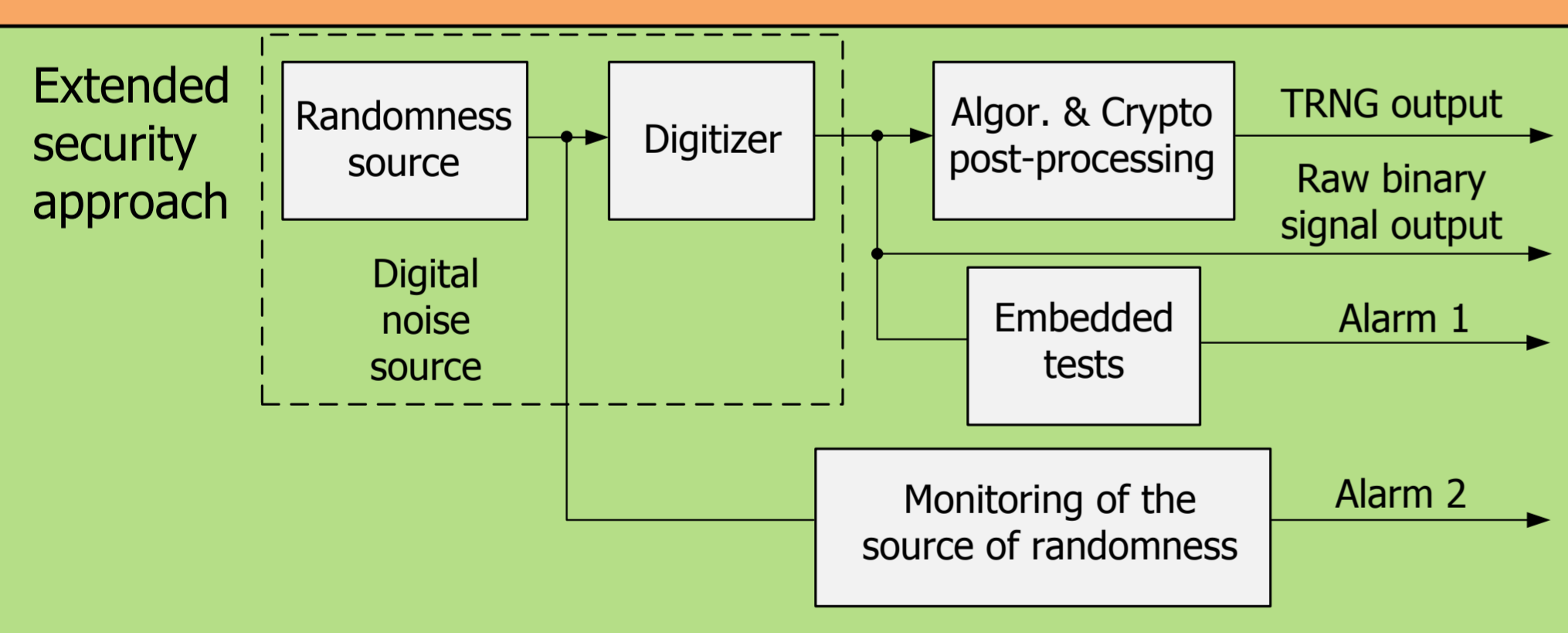

First historical application, fair TRNG comparison thanks to:

- Unified hardware platform for different FPGA and ASIC technologies
- Linear power supply
- High quality low pass filters

## SCAs

System dedicated to Side Channel Analyses

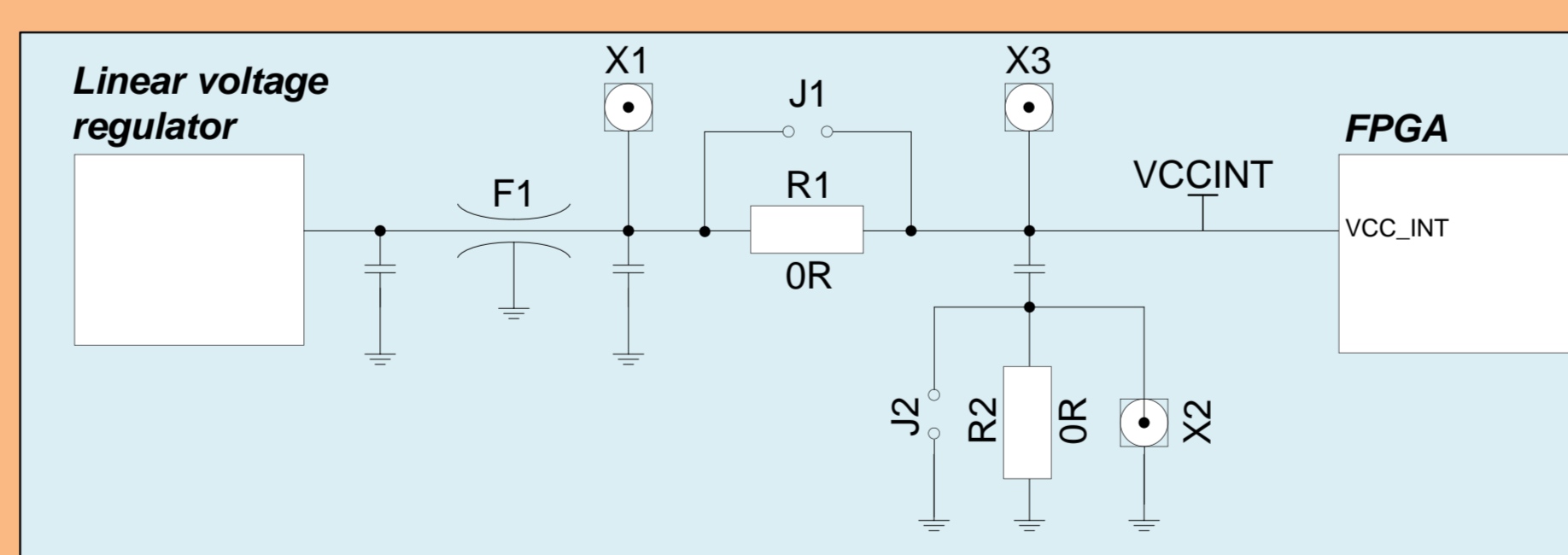

- Access to power supply lines in different places of the design
- SMA connectors for easier access and performance
- Embedded ARM processor in new modules to study software primitives

## PUFs

System dedicated to Physical Unclonable Functions

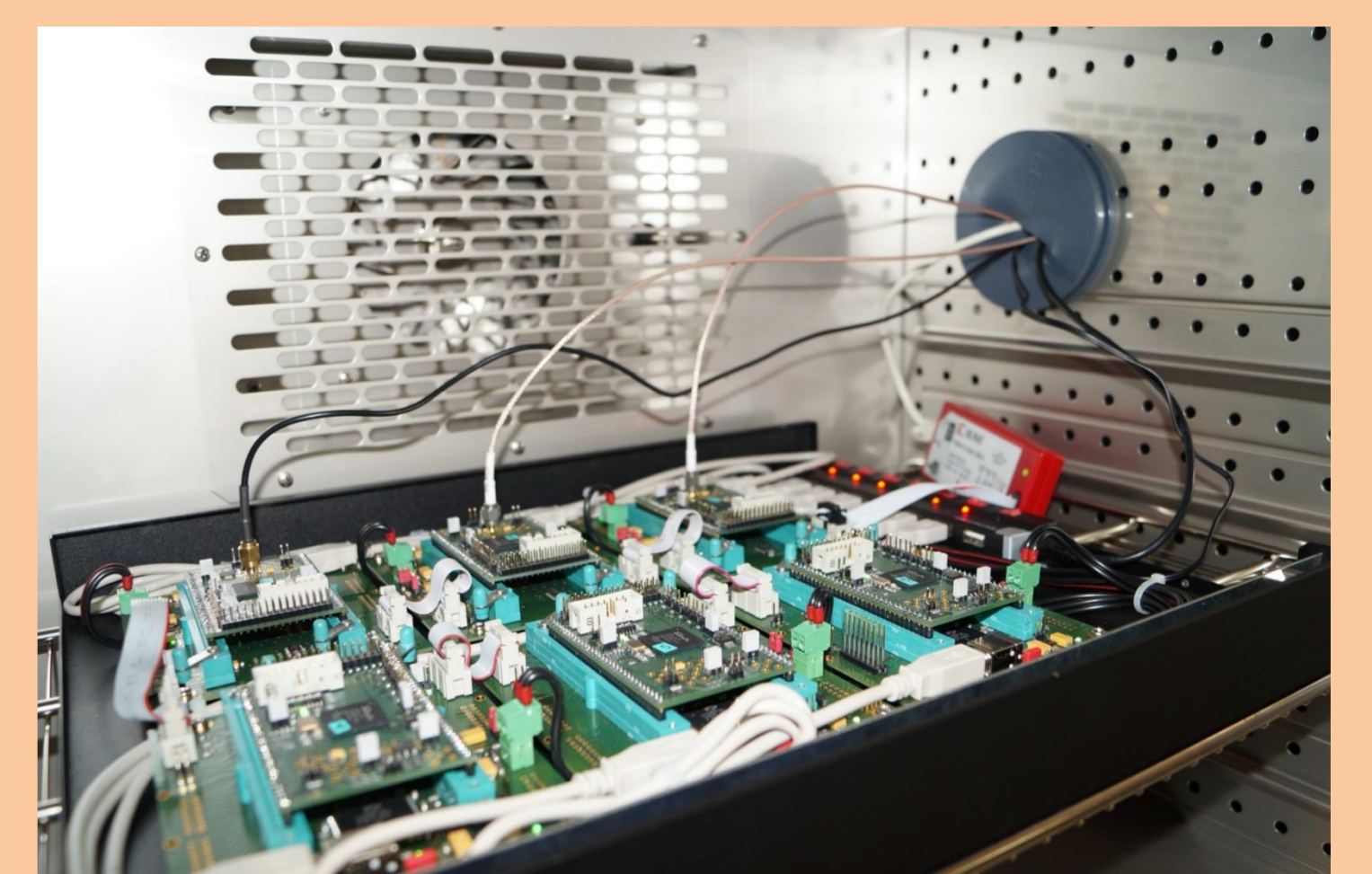

- Evaluation of up to 6 modules in parallel with 6 motherboards placed in a box
- JTAG chain for reconfiguration in situ
- Zero insertion force connectors to facilitate exchange of modules

1. FISCHER V., HADDAD P., BERNARD F., (2013) : « An open-source multi-FPGA modular system for fair benchmarking of true random number generators », 23rd international conference on field programmable logic and applications (FPL2013), pp. PS3\_8, Porto, Portugal

<http://labh-curien.univ-st-etienne.fr/wiki-evariste/>



Sources of funding:

European Union's Horizon 2020 research and innovation program: HECTOR - Hardware Enabled Crypto and Randomness - grant agreement No 644052.  
 ANR 2013 call: SALWARE - Salutory hardware design to fight against integrated circuit counterfeiting and theft - ANR-13-JS03-0003.  
 NATO SFP (Science for Peace) 2013: SFPP 984520 "Secure implementation of post-quantum cryptography".

